

INSTALLATION INSTRUCTION

Step and Wall Light

4011

WAC LIGHTING
Responsible Lighting®

WARNING

IMPORTANT: NEVER attempt to do any work without shutting off the electricity.

1. Read all instructions before installing.
2. System is intended for installation by a qualified electrician in accordance with the National Electrical Code and local regulations.
3. Place the wall switch in the "OFF" position.
4. Go to the main fuse box, or circuit breaker. Unscrew the fuse(s) or switch "OFF" the circuit breaker switch(es) that control the power to the space that you are working on.

CAUTION

- All parts must be used as indicated in these instructions. Do not substitute any parts, leave parts out, or use any parts that are worn out or broken. Failure to follow this instruction may invalidate the UL/CUL listing of this fixture.

AVERTISSEMENT

IMPORTANT : Coupez l'électricité avant TOUTE manipulation.

- Lisez toutes les instructions avant d'installer.
- Système est destiné à être installé par un électricien qualifié en conformité avec le code national de l'électricité et les règlements locaux.
- Placez l'interrupteur mural en position d'arrêt (« OFF »).
- Toujours mettre le fusible ou le disjoncteur en position arrêt dans la pièce ou des travaux électriques sont prévus

MISE EN GARDE

- Toutes les pièces doivent être utilisées tel qu'il est indiqué dans ces instructions. Ne remplacez pas les pièces, n'en laissez pas de côté et ne les utilisez pas si elles sont usées ou brisées. Le non-respect de ces instructions peut annuler l'homologation UL /CUL du luminaire.

ADVERTENCIA

IMPORTANTE: NUNCA intente hacer trabajos sin desconectar el suministro eléctrico.

- Lea y comprenda todas las instrucciones e ilustraciones por completo antes de proceder con el ensamblaje e instalación de esta lámpara.
- Sistema está diseñado para ser instalado por un electricista calificado, de acuerdo con el código eléctrico nacional y las normas locales.
- Coloque el interruptor de la pared en la posición "OFF" (APAGADO).
- Diríjase a la caja de fusibles o a la caja del interruptor de circuito principal en su hogar. Coloque el interruptor de alimentación principal en la posición "OFF" (APAGADO).

PRECAUCIÓN

- Todas las piezas deben usarse como lo indican estas instrucciones. No reemplace las piezas, no omita piezas durante la instalación ni utilice piezas gastadas o rotas. El incumplimiento de esta indicación podría invalidar la calificación UL/CUL esta lámpara.

MOUNTING ACCESSORIES (INCLUDED IN BOX)



Ruber Washer
Qty: 2pcs



Mounting Screw
Qty: 2pcs



Wire Nut
Qty: 2pc

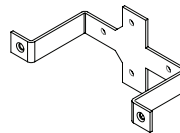

Mounting Bracket
Qty: 1pc



Junction Box Screw
Qty: 2pc

*Note: Transformer is required to power the fixture. (sold separately)

waclighting.com

Phone (800) 526.2588

Fax (800) 526.2585

Headquarters/Eastern Distribution Center

44 Harbor Park Drive

Port Washington, NY 11050

Central Distribution Center

1600 Distribution Ct

Lithia Springs, GA 30122

Western Distribution Center

1750 Archibald Avenue

Ontario, CA 91760

INSTALLATION INSTRUCTION

Step and Wall Light

4011

WAC LIGHTING

Responsible Lighting®

STEP 1: DETERMINE MOUNTING POSITION

**Note: Transformer is required to power the fixture. (sold separately)*

1. Make sure the main power supply to your transformer is turned off.
2. Install a 2" by 4" junction box, and ensure it is water-tight for outdoor use.
3. Secure the mounting bracket to the junction box using two 8-32 junction box screws.
4. Connect the fixture wires to the landscape wires from the transformer using the wire nuts provided.
5. Place all wiring and connectors back in the junction box.
6. Use the rubber washer and mounting screw to install and secure the fixture to the mounting surface.

Note: It is recommended that the installer run a bead of clear, outdoor-rated silicone (GE RTV-162 or equivalent, provided by others) caulk between gasket or back of fixture and mounting surface to prevent seepage of water into fixture)

Mounting Surface to prevent seepage of water into fixture

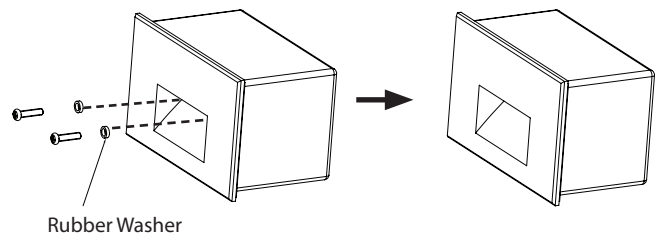
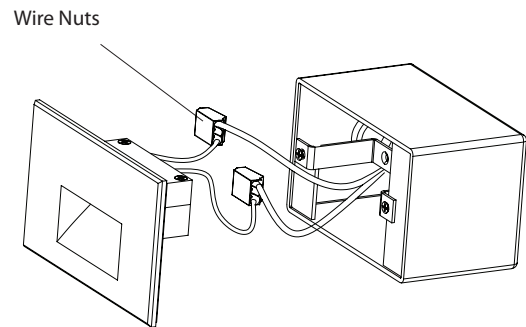
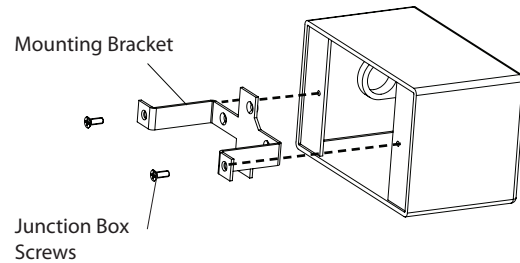

waclighting.com
Phone (800) 526.2588
Fax (800) 526.2585

Headquarters/Eastern Distribution Center
44 Harbor Park Drive
Port Washington, NY 11050

Central Distribution Center
1600 Distribution Ct
Lithia Springs, GA 30122

Western Distribution Center
1750 Archibald Avenue
Ontario, CA 91760

INSTALLATION INSTRUCTION

Step and Wall Light

4021

WAC LIGHTING
Responsible Lighting®

WARNING

IMPORTANT: NEVER attempt to do any work without shutting off the electricity.

1. Read all instructions before installing.
2. System is intended for installation by a qualified electrician in accordance with the National Electrical Code and local regulations.
3. Place the wall switch in the "OFF" position.
4. Go to the main fuse box, or circuit breaker. Unscrew the fuse(s) or switch "OFF" the circuit breaker switch(es) that control the power to the space that you are working on.

CAUTION

- All parts must be used as indicated in these instructions. Do not substitute any parts, leave parts out, or use any parts that are worn out or broken. Failure to follow this instruction may invalidate the UL/CUL listing of this fixture.

AVERTISSEMENT

IMPORTANT : Coupez l'électricité avant TOUTE manipulation.

- Lisez toutes les instructions avant d'installer.
- Système est destiné à être installé par un électricien qualifié en conformité avec le code national de l'électricité et les règlements locaux.
- Placez l'interrupteur mural en position d'arrêt (« OFF »).
- Toujours mettre le fusible ou le disjoncteur en position arrêt dans la pièce ou des travaux électriques sont prévus

MISE EN GARDE

- Toutes les pièces doivent être utilisées tel qu'il est indiqué dans ces instructions. Ne remplacez pas les pièces, n'en laissez pas de côté et ne les utilisez pas si elles sont usées ou brisées. Le non-respect de ces instructions peut annuler l'homologation UL /CUL du luminaire.

ADVERTENCIA

IMPORTANTE: NUNCA intente hacer trabajos sin desconectar el suministro eléctrico.

- Lea y comprenda todas las instrucciones e ilustraciones por completo antes de proceder con el ensamblaje e instalación de esta lámpara.
- Sistema está diseñado para ser instalado por un electricista calificado, de acuerdo con el código eléctrico nacional y las normas locales.
- Coloque el interruptor de la pared en la posición "OFF" (APAGADO).
- Diríjase a la caja de fusibles o a la caja del interruptor de circuito principal en su hogar. Coloque el interruptor de alimentación principal en la posición "OFF" (APAGADO).

PRECAUCIÓN

- Todas las piezas deben usarse como lo indican estas instrucciones. No reemplace las piezas, no omita piezas durante la instalación ni utilice piezas gastadas o rotas. El incumplimiento de esta indicación podría invalidar la calificación UL/CUL esta lámpara.

MOUNTING ACCESSORIES (INCLUDED IN BOX)



Ruber Washer
Qty: 2pcs



Mounting Screw
Qty: 2pcs



Wire Nut
Qty: 2pc

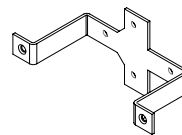

Mounting Bracket
Qty: 1pc



Junction Box Screw
Qty: 2pc

*Note: Transformer is required to power the fixture. (sold separately)

waclighting.com

Phone (800) 526.2588

Fax (800) 526.2585

Headquarters/Eastern Distribution Center

44 Harbor Park Drive

Port Washington, NY 11050

Central Distribution Center

1600 Distribution Ct

Lithia Springs, GA 30122

Western Distribution Center

1750 Archibald Avenue

Ontario, CA 91760

INSTALLATION INSTRUCTION

Step and Wall Light

4021

WAC LIGHTING

Responsible Lighting®

STEP 1: DETERMINE MOUNTING POSITION

**Note: Transformer is required to power the fixture. (sold separately)*

1. Make sure the main power supply to your transformer is turned off.
2. Install a 4" by 2" junction box, and ensure it is water-tight for outdoor use.
3. Secure the mounting bracket to the junction box using two 8-32 junction box screws.
4. Connect the fixture wires to the landscape wires from the transformer using the wire nuts provided.
5. Place all wiring and connectors back in the junction box.
6. Use the rubber washer and mounting screw to install and secure the fixture to the mounting surface.

Note: It is recommended that the installer run a bead of clear, outdoor-rated silicone (GE RTV-162 or equivalent, provided by others) caulk between gasket or back of fixture and mounting surface to prevent seepage of water into fixture)

Mounting Surface to prevent seepage of water into fixture

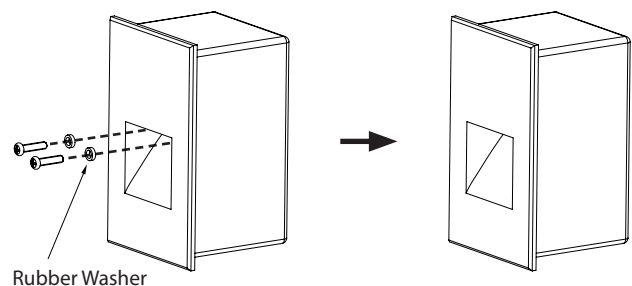
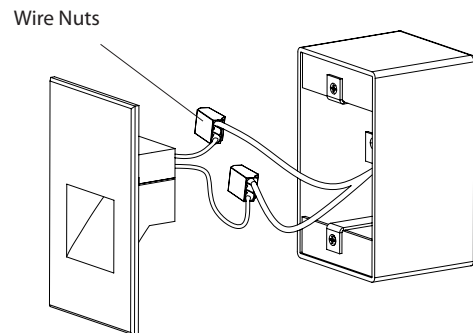
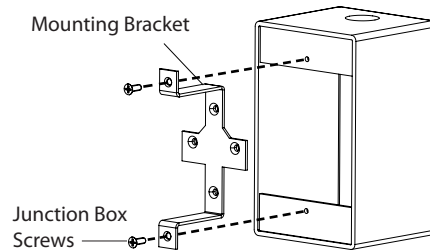

waclighting.com
Phone (800) 526.2588
Fax (800) 526.2585

Headquarters/Eastern Distribution Center
44 Harbor Park Drive
Port Washington, NY 11050

Central Distribution Center
1600 Distribution Ct
Lithia Springs, GA 30122

Western Distribution Center
1750 Archibald Avenue
Ontario, CA 91760